

SCALE 1:1

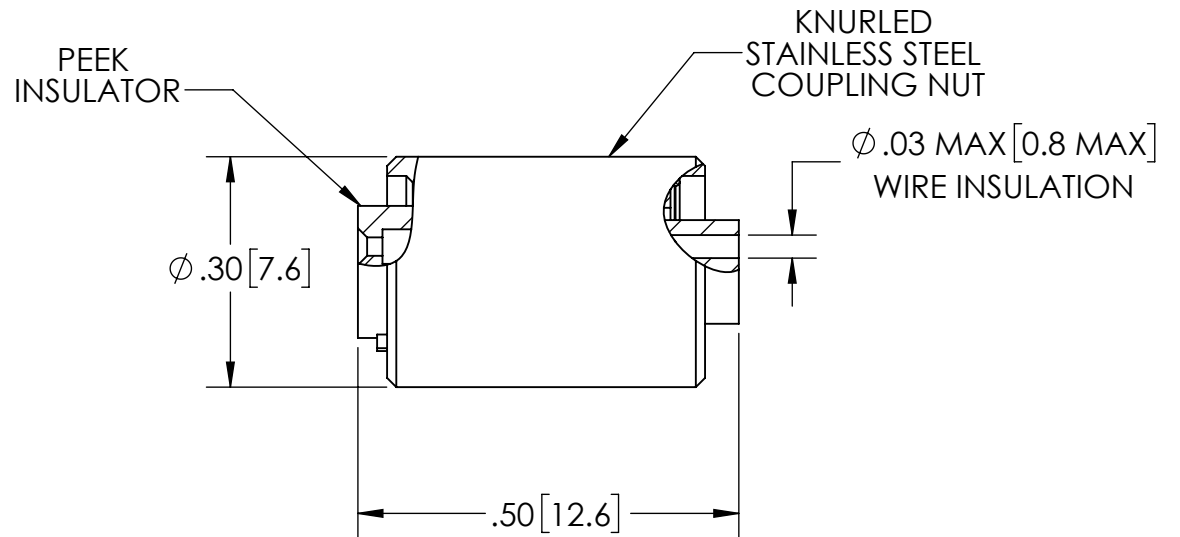

**CONTACTS ARE SOLD SEPARATELY**

- GOLD PLATED BRASS/BeCu CRIMP CONTACTS: KT41236
- GOLD PLATED TeCu/BeNi CRIMP CONTACTS: KT41236-02

PERFORMANCE SPECIFICATIONS	
VOLTAGE:	250V DC
TEMPERATURE (WITHOUT CONTACTS):	-55°C TO 200°C*

\*CONTACTS MAY LIMIT HIGHER TEMPERATURE

REFER TO INSTRUCTION SHEET "NS42930" FOR PLUG ASSEMBLY INSTRUCTIONS

PROPRIETARY AND CONFIDENTIAL THE INFORMATION CONTAINED IN THIS DRAWING IS THE SOLE PROPERTY OF SOLID SEALING TECHNOLOGY. ANY REPRODUCTION IN PART OR AS A WHOLE WITHOUT THE WRITTEN PERMISSION OF SOLID SEALING TECHNOLOGY IS PROHIBITED.				THIRD ANGLE PROJECTION 		TITLE <b>3 PIN MICRO C PLUG</b>			
REV.	APP'D	DATE	SCALE 4:1	DIMENSIONS IN INCHES [mm]	DRAWN	HJ	08/11/2021	PART NO. FA42930 REV. A WWW.SOLIDSEALING.COM	
A1	HJ	08/17/2021	MSPLR004-03		ENG APPR.	HJ	08/17/2021		

**DIMENSIONS ARE FOR REFERENCE ONLY. UNLESS NOTED, NO TOLERANCES ARE IMPLIED. CONSULT SST TO DISCUSS YOUR SPECIFIC REQUIREMENTS.**

### 3 PINS

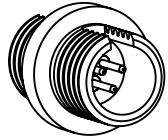

HERMETIC FEEDTHRU  
FA42916  
(LASER WELD ONLY)

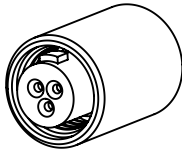

PLUG  
FA42930\*

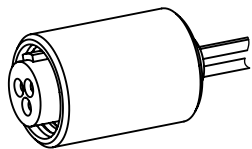

PRE-WIRED PLUG  
-KAPTON: FA43039  
-PTFE: FA43040

### 7 PINS

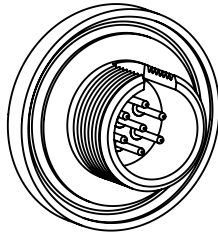

HERMETIC FEEDTHRU  
FA41283

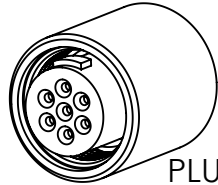

PLUG  
FA41289\*

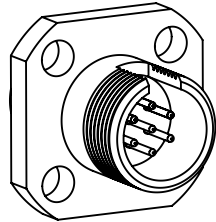

IN-VAC RECEPTACLE  
FA42367

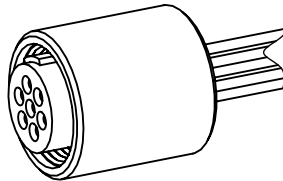

PRE-WIRED PLUG  
-KAPTON: FA42314  
-PTFE: FA42315

### 19 PINS

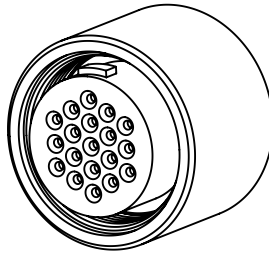

PLUG  
FA41232\*

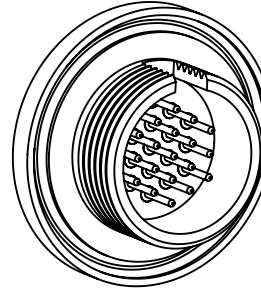

HERMETIC FEEDTHRU  
FA41401

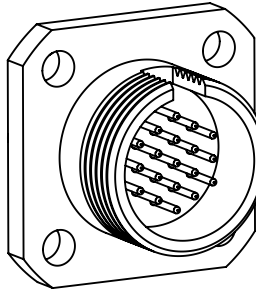

IN-VAC RECEPTACLE  
FA41656

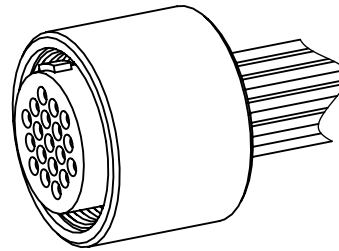

PRE-WIRED PLUG  
-KAPTON: FA42316  
-PTFE: FA42317

### 55 PINS

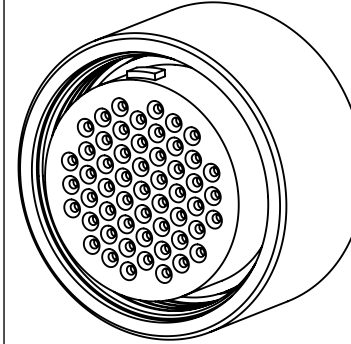

PLUG  
FA42256\*

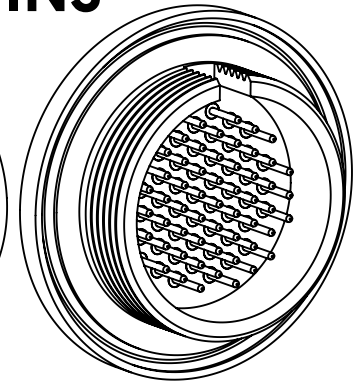

HERMETIC FEEDTHRU  
FA42250

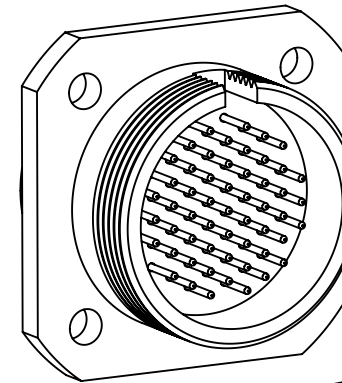

IN-VAC RECEPTACLE  
FA42375

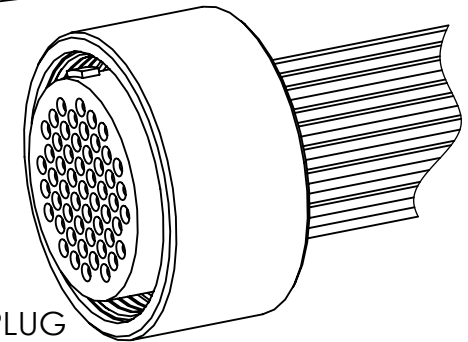

PRE-WIRED PLUG  
-KAPTON: FA42318  
-PTFE: FA42319

**\*CONTACTS NOT INCLUDED**

PROPRIETARY AND CONFIDENTIAL

THE INFORMATION CONTAINED IN THIS DRAWING IS THE SOLE PROPERTY OF SOLID SEALING TECHNOLOGY. ANY REPRODUCTION IN PART OR AS A WHOLE WITHOUT THE WRITTEN PERMISSION OF SOLID SEALING TECHNOLOGY IS PROHIBITED.

THIRD ANGLE PROJECTION

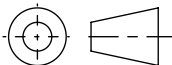

TITLE

MICRO SERIES FAMILY



**SOLID SEALING TECHNOLOGY**

REV.	APP'D	DATE	SCALE 2:1	DIMENSIONS IN INCHES [mm]	DRAWN	HJ	04/09/2021
A2	CW	4/21/2022	MPC10735-11		ENG APPR.	HJ	05/03/2021

REV: A2

WWW.SOLIDSEALING.COM

SALES DWG NO. MICRO\_SERIES REV. A2

**DIMENSIONS ARE FOR REFERENCE ONLY. UNLESS NOTED, NO TOLERANCES ARE IMPLIED. CONSULT SST TO DISCUSS YOUR SPECIFIC REQUIREMENTS.**

# 9 PINS

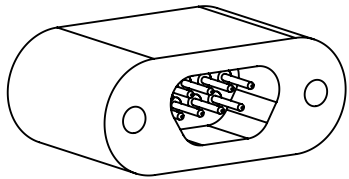

HERMETIC FEEDTHROUGH FA41500

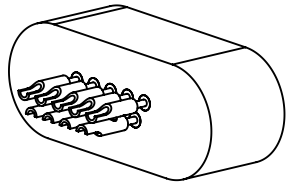

HERMETIC SOLDERCUP FEEDTHROUGH FA42164

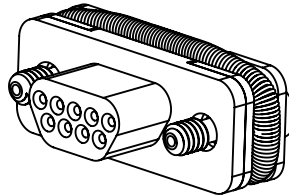

PLUG, GARTER TYPE FA42137

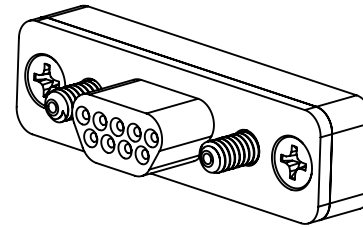

PLUG, SCREW TYPE: FA41506  
PRE-WIRED PLUG  
-KAPTON: FA42239  
-PTFE: FA42419

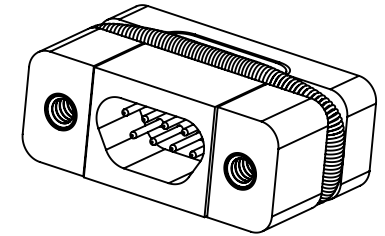

IN-VAC RECEPTACLE FA42394

# 15 PINS

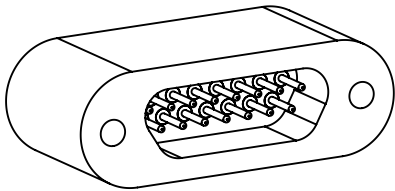

HERMETIC FEEDTHROUGH FA42273

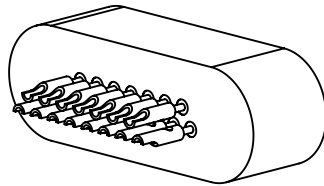

HERMETIC SOLDERCUP FEEDTHROUGH FA42467

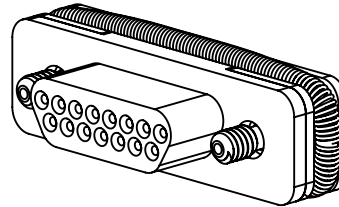

PLUG, GARTER TYPE FA42475

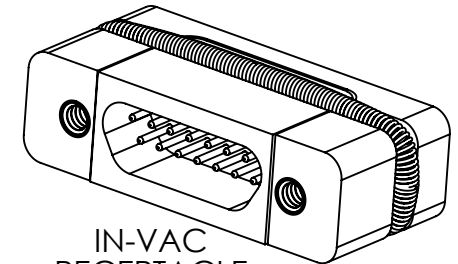

IN-VAC RECEPTACLE FA42488

# CONTACTS/WIRE

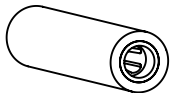

SOCKET CONTACTS  
KT41236 (BRASS 125C)  
KT41236-02 (TeCu 250C)

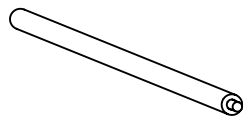

WIRE  
KAPTON 48": FA42244  
KAPTON 96": FA42245  
PTFE 48": FA42246-01/09  
PTFE 96": FA42247-01/09



CRIMP TOOL POSITIONER (PIN & SOCKET) FP41731

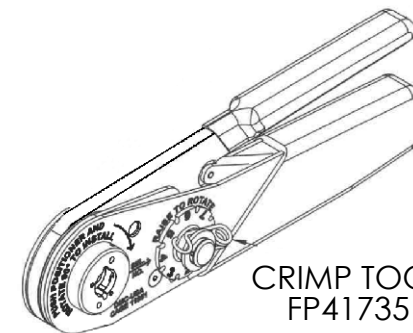

CRIMP TOOL FP41735

PROPRIETARY AND CONFIDENTIAL

THE INFORMATION CONTAINED IN THIS DRAWING IS THE SOLE PROPERTY OF SOLID SEALING TECHNOLOGY. ANY REPRODUCTION IN PART OR AS A WHOLE WITHOUT THE WRITTEN PERMISSION OF SOLID SEALING TECHNOLOGY IS PROHIBITED.

THIRD ANGLE PROJECTION

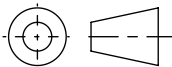

TITLE

MICRO SERIES FAMILY



**SOLID SEALING**  
TECHNOLOGY

REV.	APP'D	DATE	SCALE 2:1	DIMENSIONS IN INCHES [mm]	DRAWN	HJ	04/09/2021
A2	CW	4/21/2022	AHDWR027-41		ENG APPR.	HJ	05/03/2021

REV. A2

WWW.SOLIDSEALING.COM

SALES DWG NO. MICRO\_SERIES REV. A2

**DIMENSIONS ARE FOR REFERENCE ONLY. UNLESS NOTED, NO TOLERANCES ARE IMPLIED. CONSULT SST TO DISCUSS YOUR SPECIFIC REQUIREMENTS.**